

Model # 954-W6

SAFETY WARNINGS & EQUIPMENT INSPECTION

- Owners and installers please note these safety warnings and make use of this checklist on a regular basis.
- Follow installation instructions when erecting equipment.
- Ground surfaces around equipment should be restored as needed. Concrete footings should never be exposed. Surface depth should comply with ASTM and CPSC specifications.
- Check for and repair damage caused by wear or vandalism, a major factor in injury causing situations.
- All protruding bolts should be covered or cut off and finished smooth. Sharp edges on pipes should be capped or removed. Check for bent, broken, or severely worn pipe, and replace.
- All equipment should be free of rust and repainted whenever necessary to deter rusting.
- We provide our customers with layout sheets and installation instructions. Please keep on file the specifications sheet that contains the listing of every part used.
- Never add components not intended for use with this product.
- Regular maintenance is necessary in this and all park and recreational equipment to insure the safety of the user.
- Note: Proper maintenance of equipment requires regular tightening of all bolts, nuts, and setscrews.
- Note: Regular checking of all parts, castings, etc. should be made. If a part is broken or worn, it should be replaced immediately.
- Check to be sure all fittings are tight and that bars and pipes do not move.
- Replace all worn S-hooks. S-hooks must be completely closed. Failure to close S-hooks can result in serious injury to the user. NEVER reuse S-hooks.
- Test for free movement of swing hanger and other moving attached parts.
- Check for worn chains and replace them.
- A soft resilient surface should be placed under all swings extending at least twice the height of the top rail both front and back.

HARDWARE

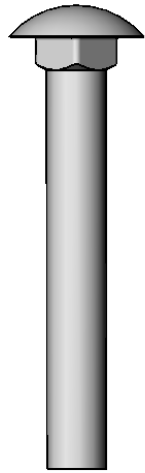

5/16" x 2-1/4"
Carriage Bolt

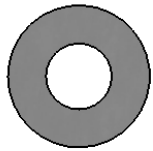

5/16" Washer



5/16" Kep Nut

TOOLS REQUIRED

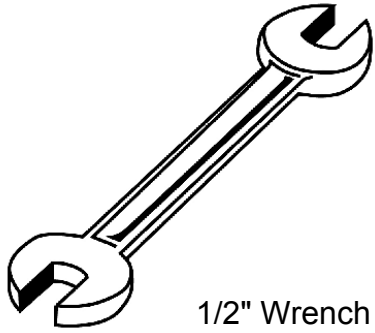

1/2" Wrench

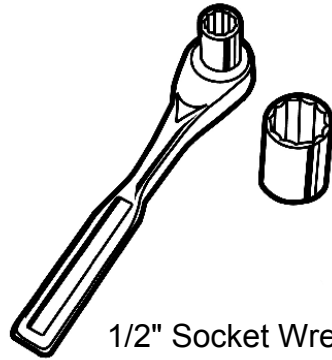

1/2" Socket Wrench

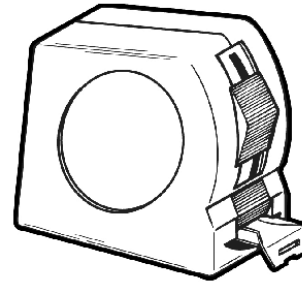

Tape Measure

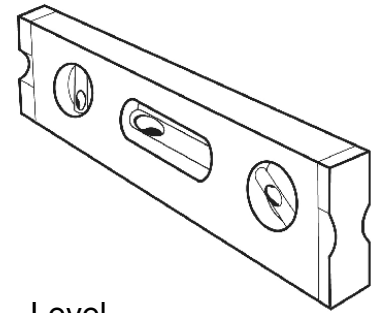

Level

PRODUCT SPECIFICATIONS

954-W6 LEXINGTON BENCH WITH BACK

Seats: Seats dimensions are 18" x 20" x 72". 12 gauge die formed flat steel plate with punched design. End plates are made of 10 gauge flat steel plate. Reinforced with 3/16 x 1-1/2" flat strip. Electrically MIG welded.

Frame: Legs are cast aluminum

Seat & Frame Coating: Oven fused functionalized polyethylene copolymer-based thermoplastic. Fluidized bed coating application with superior mechanical performance, impact resistance and UV-stability.

Hardware: All stainless steel hardware fasteners.

Dimensions: 6' portable/surface mount bench with back. Seats are 25-1/2" wide x 72" long. Seat height is 18" from the ground to the top of the seat. The overall dimensions are 75" x 27" x 35-1/2".

COMPONENTS

Attach the 6' Contour Seat to the 954 Legs using specified hardware.

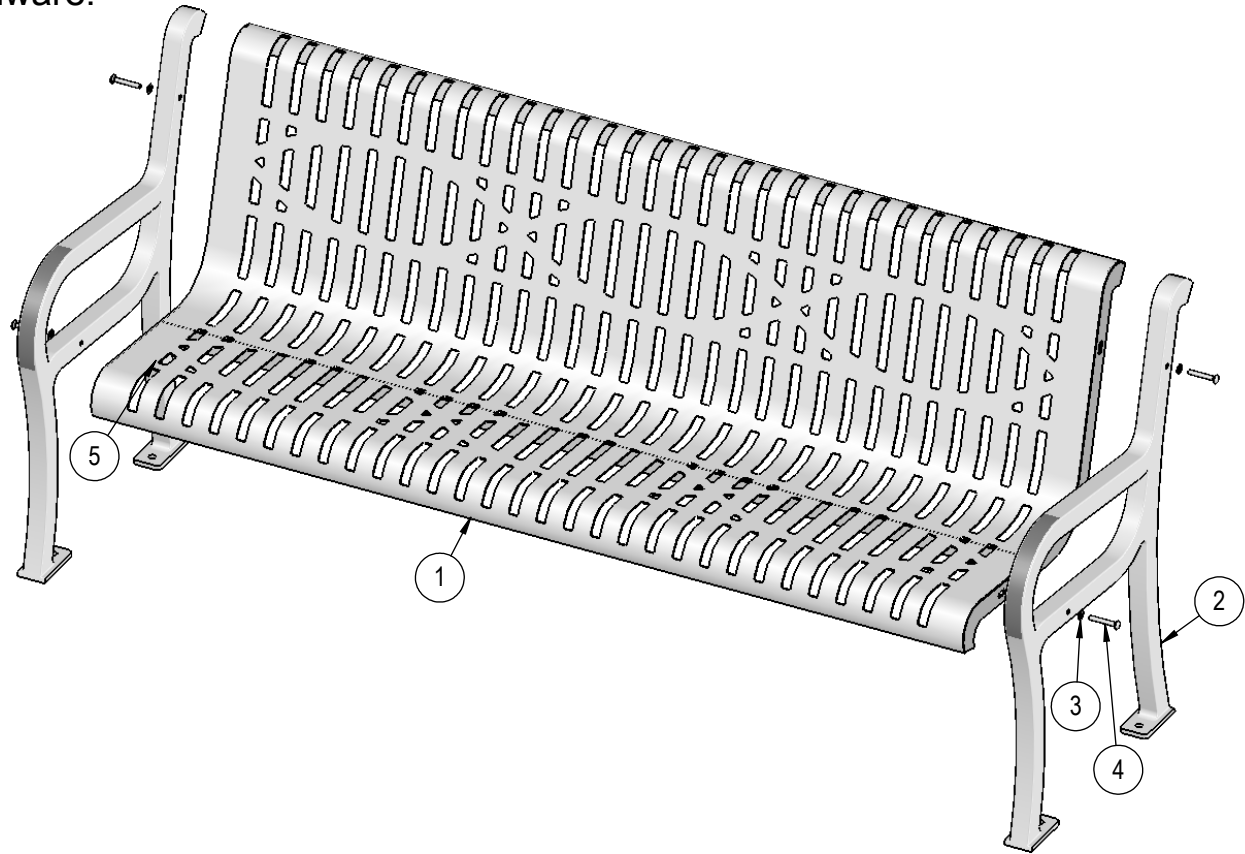

ITEM NO.	PartNo	DESCRIPTION	QTY
1	T-W72CT-S	6' Wave Contour Seat	1
2	T-11-01-CAST	954 Cast Endframe	2
3	33-02-0007	5/16" Flat Washer (SS)	8
4	33-06-0053	5/16" x 2-1/4" Carriage Bolt (SS)	4
5	33-03-0012	5/16" Kep Nut (SS)	4

Optional Surface Mount Hardware:
3/8" x 3-1/2" Concrete Expansion Anchor Bolts
(Not Included)

OVERALL DIMENSIONS

