

# Wheelchair Accessible Concrete Tables Assembly Instructions

## Note:

Once table is assembled, it should NOT be moved, as structural damage may result. Ensure the table is in its final location before assembling.

### TABLE ANCHOR METHOD

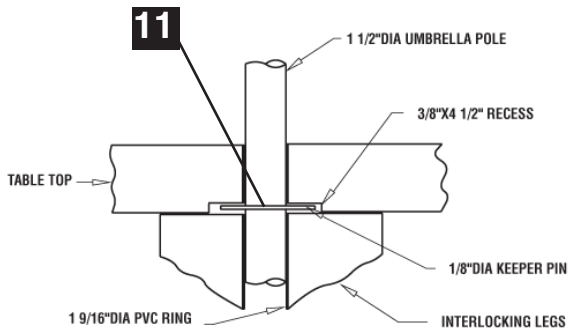
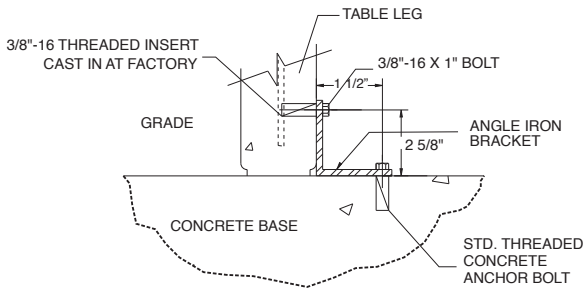

### UMBRELLA LOCK

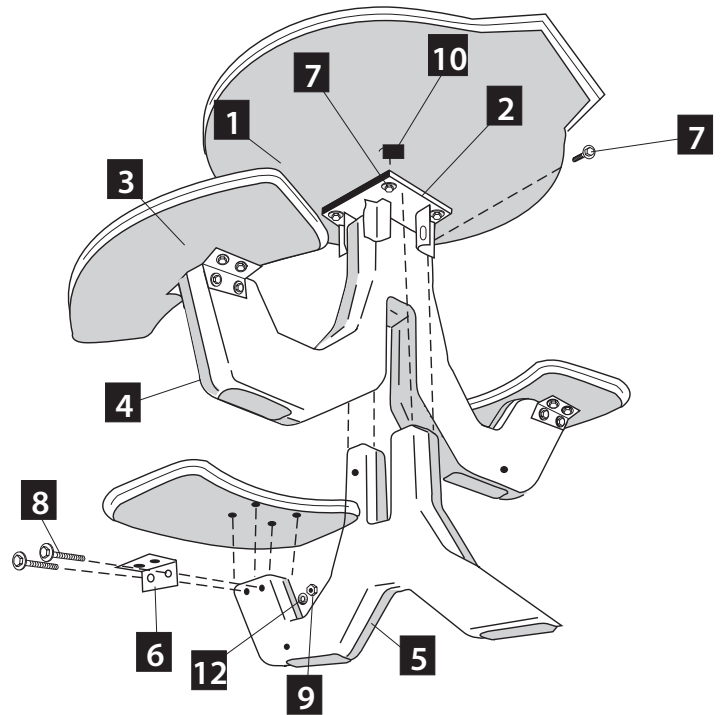

### CAUTION

DO NOT OVER TIGHTEN ANY BOLTS  
TORQUE ALL FASTENERS TO MAX. 25 ft/lbs

## Note:

THE TABLE LEG HAS BEEN DESIGNED TO FUNCTION AS YOUR UMBRELLA STAND. REMOVE KNOCK-OUT PLUG IN TABLE TOP PRIOR TO FINAL ASSEMBLY. THIS MEANS THAT THE UMBRELLA POLE DOES NOT REST AT GROUND LEVEL, BUT IS SUPPORTED APPROXIMATELY 18" ABOVE GRADE. YOU MAY WANT TO CUT OFF THE UMBRELLA POLE.

### WARNING

Use of a table/umbrella combination without the keeper pin is UNSAFE. Wind may dislodge the umbrella, causing property damage or personal injury. This hardware kit includes a 3/16" dia x 3" keeper pin for your convenience.

TO REMOVE CENTER PLUG:  
TAP CONCRETE CORE INSIDE  
PVC RING PRIOR TO ASSEMBLY

PARTS LIST		
ITEM NO.	DESCRIPTION	QTY.
1	Square or Round Table	1
2	Table - To - Leg Bracket	1
3	Seat	3
4	Top Interlocking Leg	1
5	Bottom Interlocking Leg	1
6	Seat - To - Leg Bracket	6
7	3/8" x 1" Hex Flange Bolts	16
8	3/8" x 5 1/2" Hex Bolts	10
9	3/8" Locking Hex Nuts	6
10	Neoprene Pad	16
11	3/16" Dia. x 3" Keeper Pin	1
12	3/8" USS Flat Washers	20

Continued on Pg. 2.

# Assembly Instructions

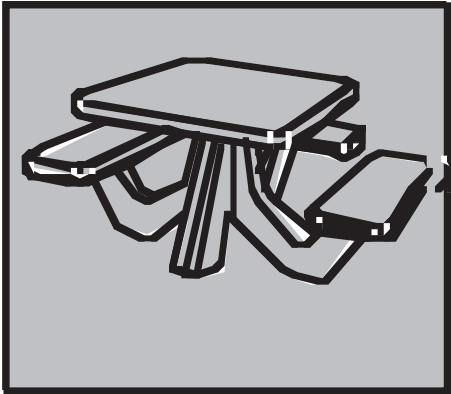

- 1.** Place interlocking legs together as shown below:

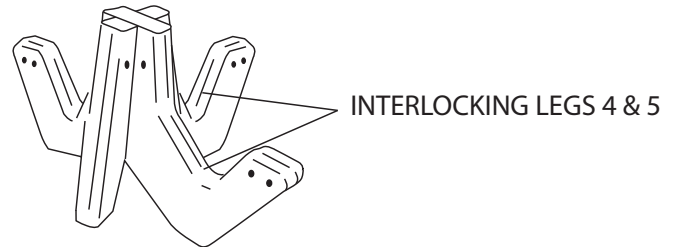

- 2.** Attach seat-to-leg brackets (6) to interlocking legs (4) & (5) with 3/8" x 5 1.2" hex flange screws (8) with locking hex nuts (9) and washers (12). **LEAVE SCREWS LOOSE.**

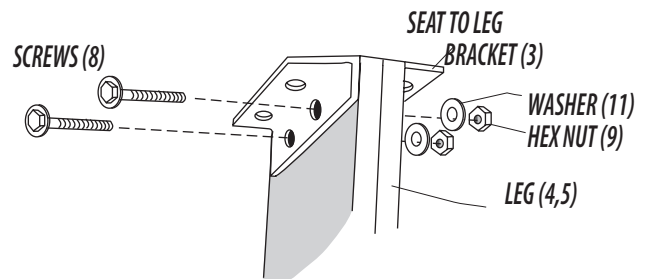

**CAUTION:** Make certain that leg brackets are assembled to the leg first and the seat is attached as described in Step 3. Failure in following these instructions may result in stress cracks to the seat assembly.

**Caution:** Table needs to be assembled on a level, hard or compacted surface in its final location. Once table is assembled it should not be moved fully assembled as structural damage may result. Failure to follow these guidelines may cause undo stress on table components and cause structural failure.

\*Warranty does not cover damage caused by improper installation.

- 3.** Attach seats (3) to seat-to-leg brackets (6) as shown below. With 3/8" hex flange bolts (7). **LEAVE SCREWS LOOSE**

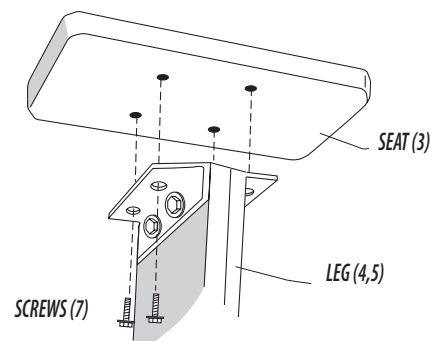

- 4.** Go back and snug up screws holding seat-to-leg brackets (6) to interlocking legs (4) & (5).

- 5.** Slide table-to-leg bracket (2) into place, and attach to legs (4) & (5). With 3/8" x 1" hex flange bolts (7). Place neoprene pads (10) around holes on bracket.

Set table top (1) on table-to-leg bracket (2). Line up holes attach top with 3/8" x 1" hex flange bolts (7). Tighten screws snug only. Torque to 25 ft/lbs. **DO NOT OVER TIGHTEN.**