

BENCH SPECIFICATIONS BC1165

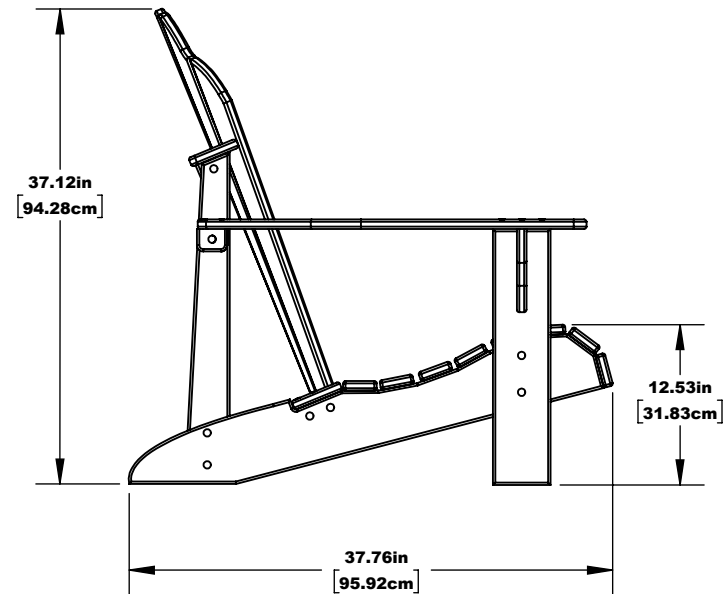
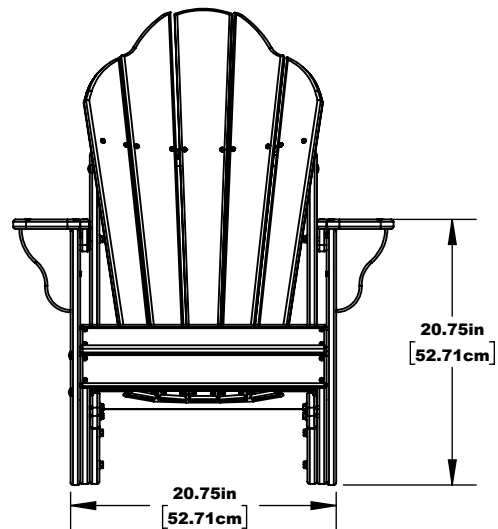
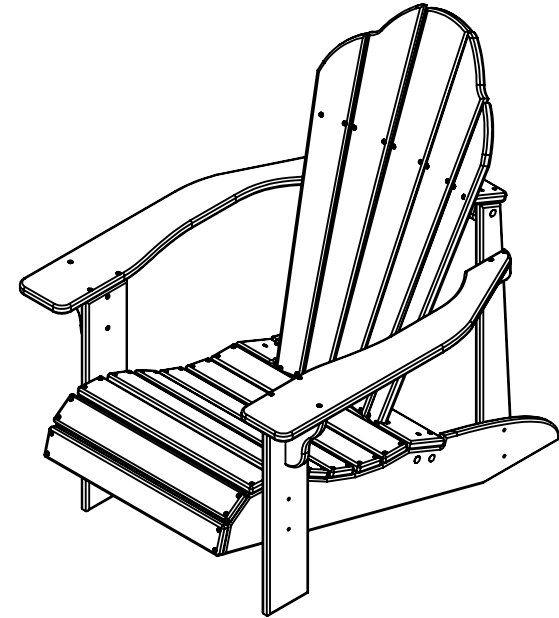
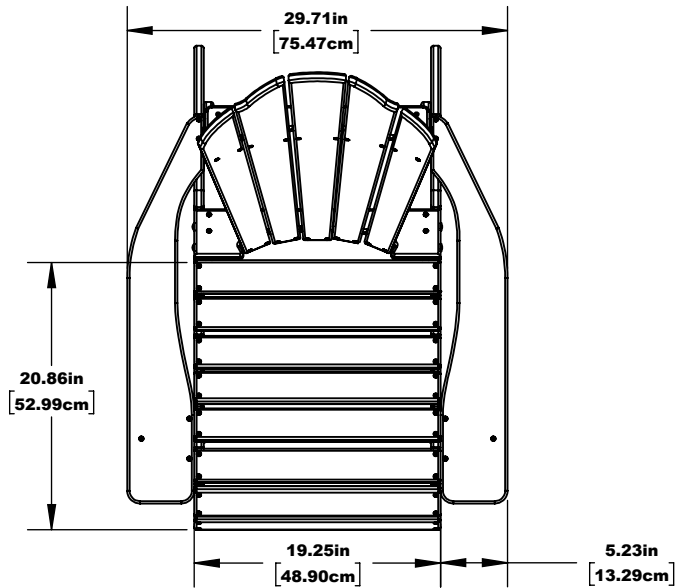

CONSTRUCTION MATERIALS:
Recycled Plastic
HARDWARE:
Stainless Steel