

RECEPTACLE SPECIFICATIONS

TR2940

REV# 1
3/7/2017

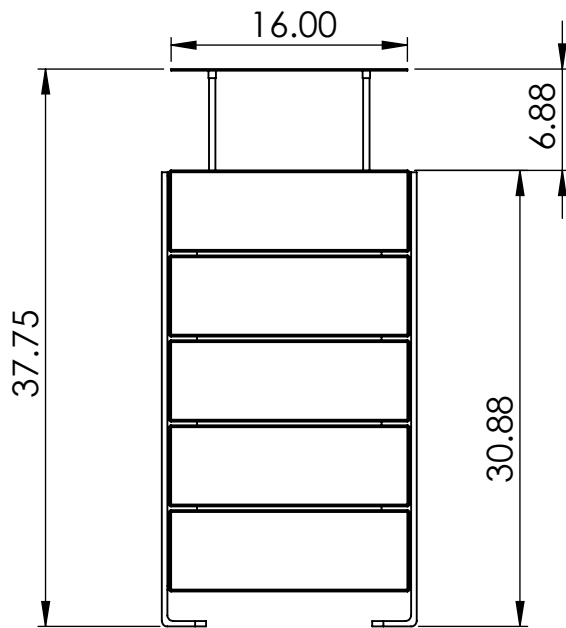
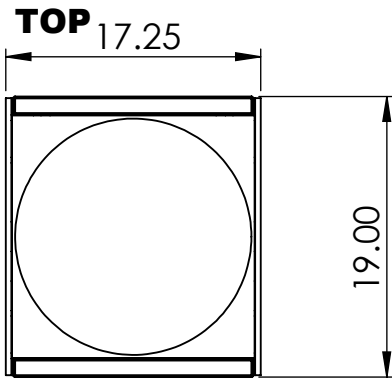

FRONT

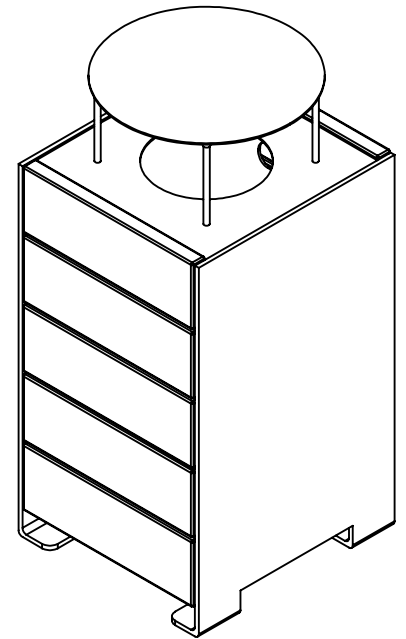
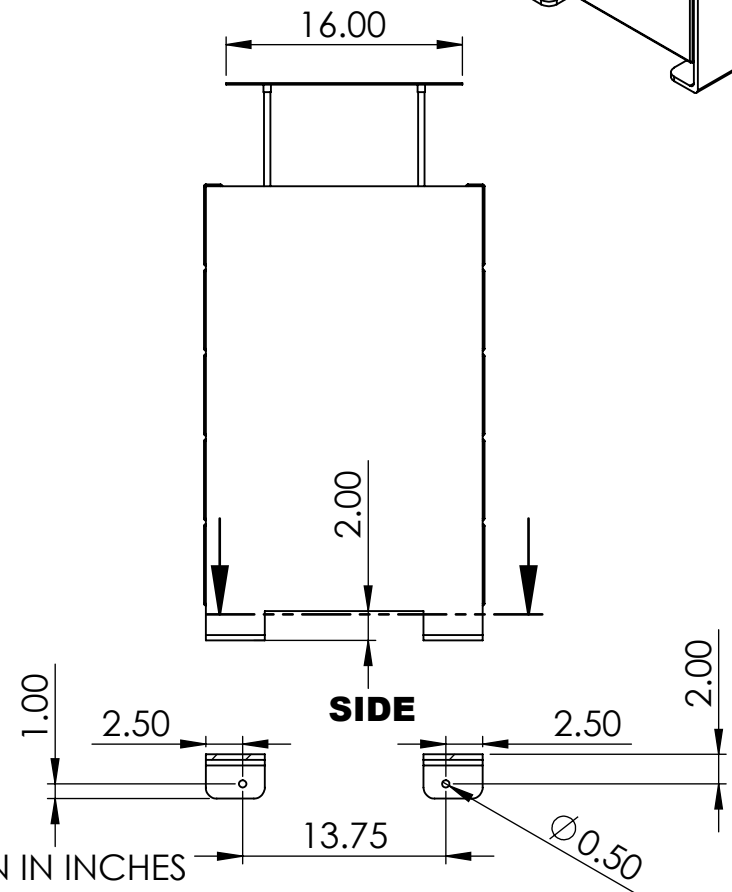

CONSTRUCTION MATERIALS:
Recycled Plastic
HARDWARE:
Stainless Steel

ALL DIMENSIONS ARE SHOWN IN INCHES