

Assembly Instructions

Umbrella Base







Please read instructions thoroughly before assembling. Familiarize yourself with the inventory of parts and the accompanying illustrations to assure safe and proper assembly.

Note: Repeated assembly can weaken the locking ability of the washers. Periodically check all bolted connections on your furniture to make sure they are tight and secure. Keep these instructions for future reference.

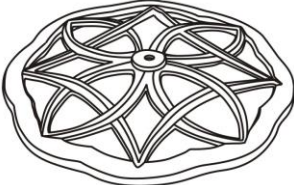
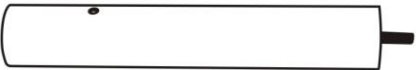
* Tools you'll need: Adjustable wrench (Not provided).

Part List:

Part List	Description	Qty	Drawings
A	Umbrella Base	1	
B	Umbrella Pole	1	
C	Pole Adapters (pre-install)	1	
D	Adjustment Knob	1	
E	Flat Washer (M10)	1	

H	Nut (M10)	1	
---	-----------	---	---

ASSEMBLY INSTRUCTIONS:

1. Screw the adjustment knob (D) into umbrella pole (B). Depending on the size of your umbrella pole, turn the adjustment knob (D) to secure pole when inserting umbrella into the base. (View Fig. 1)

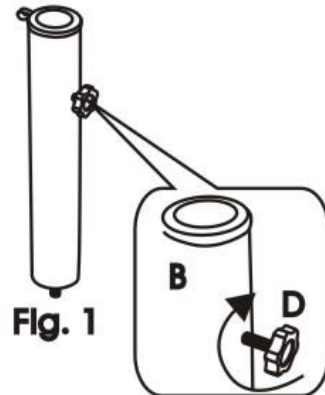

2. Attach Umbrella pole (B) to Umbrella base (A) by inserting the flat washer (E) between the bottom of the base and the Nut (F). Then tighten the nut with an adjustable wrench. (View Fig. 2)

