

HANGING CANTILEVER SHADE

20' x 12' x 8'

REF.#	PART DESCRIPTION	QTY.
1	Column - Flanged Cantilever	2
2	Beam - Flanged With Caps	2
3	Elbow - Glide	4
4	Rafter - Swaged One End	4
5	Ridge Pole - Swaged Both Ends	1
6	Joiner - Rectangle Profile	2
7	Fabric - 20' x 12' With Cable Insert	1
8	Frame Hardware Kit	1

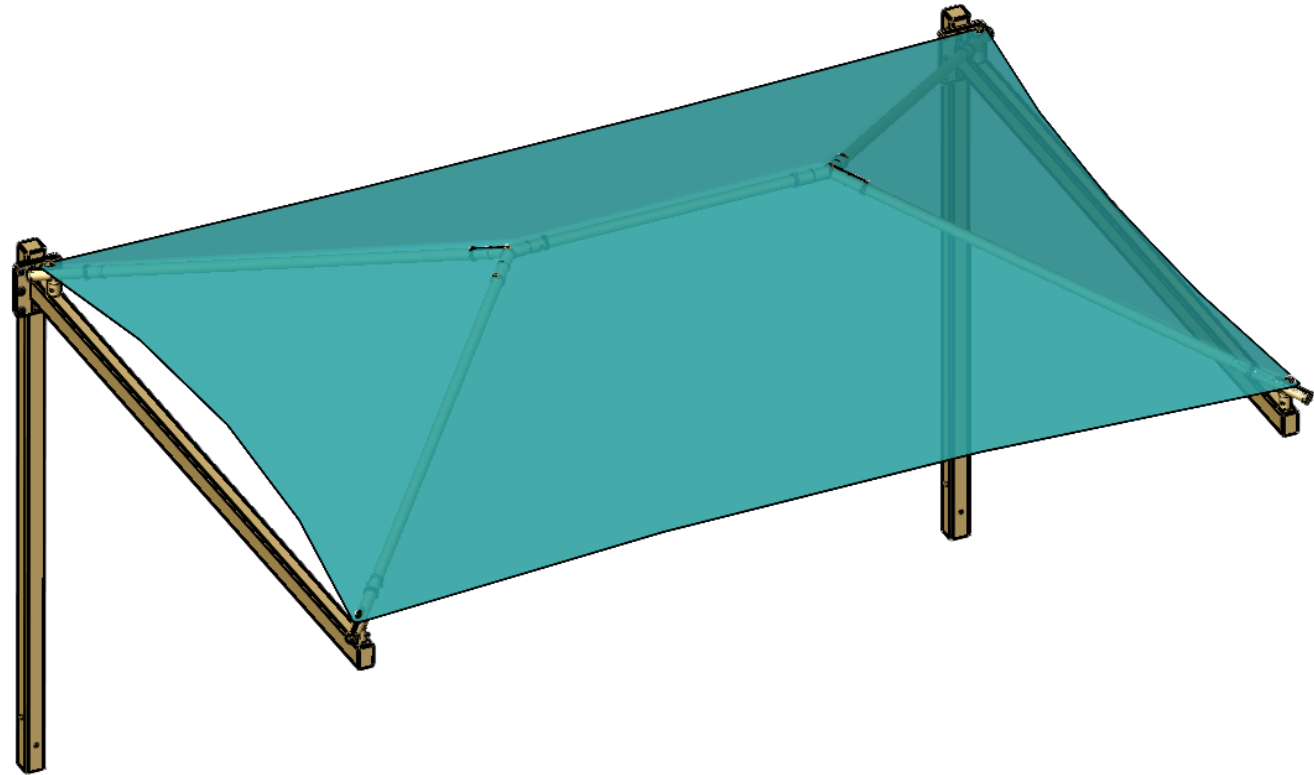
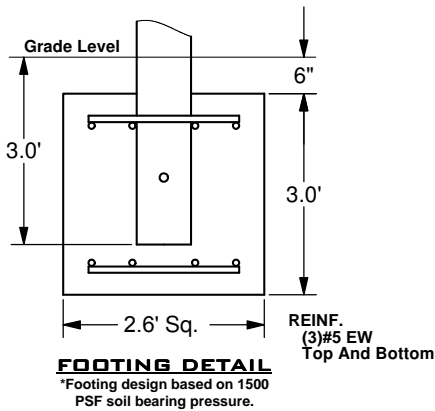
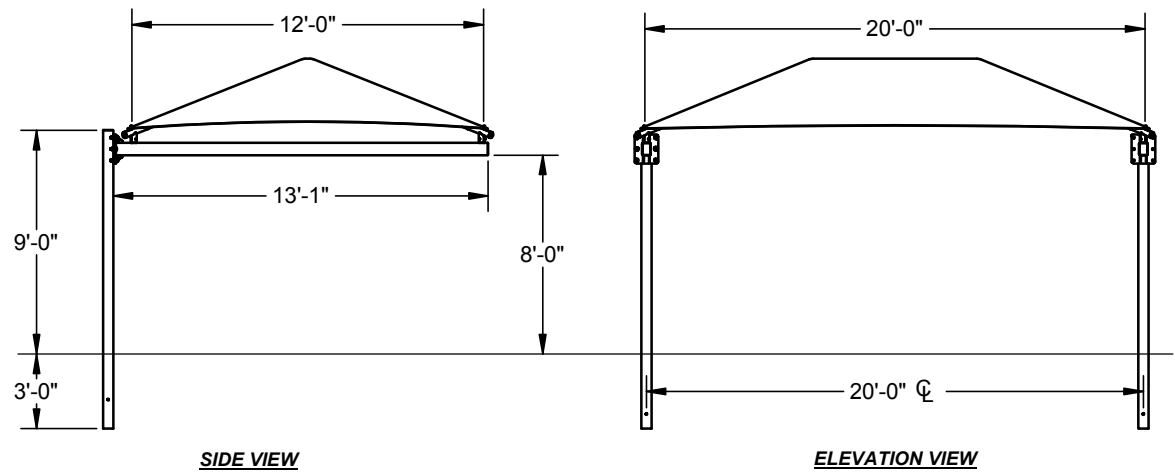

These drawings are for reference only and should not be used as construction details. Materials, fasteners, and foundations are subject to change if professionally sealed engineering drawings are required. Designed for 93 MPH Basic Wind Speed.